

# **X1-Micro 2 in 1**

**750 W / 800 W / 900 W / 1000 W / 1200 W**

## **Installation Manual**

Version 7.0

[www.solaxpower.com](http://www.solaxpower.com)











©Manual in the QR code or at <http://kb.solaxpower.com/>

## Safety

1. Contents may be periodically updated or revised. SolaX reserves the right to make improvements or changes in the product(s) and the program(s) described in this manual without the prior notice.
2. The installation, maintenance and grid-related setting can only be performed by qualified personnel who:
  - Are licensed and/or satisfy state and local jurisdiction regulations;
  - Have good knowledge of this manual and other related documents.
3. Before installing the device, carefully read, fully understand and strictly follow the detailed instruction of the user manual and other related regulations. SolaX shall not be liable for any consequences caused by the violation of the storage, transportation, installation, and operation regulations specified in this document and the user manual.
4. Use insulated tools when installing the device. Individual protective tools must be worn during installation, electrical connection and maintenance.
5. Please visit the website [www.solaxpower.com](http://www.solaxpower.com) of SolaX for more information.

### Descriptions of Labels

	CE mark of conformity		Caution, risk of danger
	Caution, risk of electric shock		Caution, hot surface
	Read the enclosed documentations		Do not dispose of the inverter together with household waste.
	ANATEL certification		TUV certification
	Danger of high voltage. Do not touch live parts for 5 minutes after disconnection from the power sources.		

### DANGER!

#### Lethal danger from electrical shock due to the inverter

- Only operate the inverter when it is technically faultless. Otherwise, electric shock or fire may occur.
- Do not open the enclosure in any case without authorization from SolaX. Unauthorized opening will void the warranty and cause lethal danger or serious injury due to electric shock.

### DANGER!

#### Lethal danger from electrical shock due to the PV

- Never touch the positive or negative pole of PV connecting device. Touching both of them at the same time is prohibited as well.
- Do not ground the positive or negative pole of the PV modules.
- Only qualified personnel can perform the wiring of the PV panels.

**WARNING!****Risk of personnel injury or inverter damage**

- During operation, do not touch any parts including the enclosure lid of the inverter.
- Never connect or disconnect the AC or DC connectors when the microinverter is running.
- Make sure that the input DC voltage  $\leq$  Maximum DC input voltage of the inverter. Overvoltage may cause permanent damage to the inverter, which is NOT covered by the warranty.
- The installation place should be away from humid or corrosive substance. Avoid installation near extremely hot/cold environment.
- Make sure that the microinverter is installed under the PV module in case of direct exposure to UV, rain and other harmful weather events.
- The front side of the microinverter needs to be installed facing the PV module. Avoid mounting the microinverter upside down.
- Avoid matching microinverters to cables that have been exposed to wet conditions.
- Avoid connecting batteries or other sources of power supply to each input of the microinverter, as each input is connected to one PV module.

**CAUTION!**

- Keep children away from the inverter.
- Only with permissions of local utility grid company, the microinverter can be connected to the grid.
- The installer must provide Over Current Protection Devices (OCPD) and external disconnect switches.

**NOTICE!**

- If an external RCD is required by local regulations, check which type of RCD is required for relevant electric codes. Values of Type A or Type AC RCD should refer to local requirements.
- All the product labels and nameplate on the inverter shall be maintained clearly visible.
- Comply with local safety rules and regulations before all electrical installations.

Scan the following QR code to acquire Safety Regulations in multiple languages:



## Packing List

Including in the box:

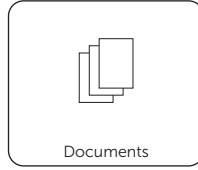
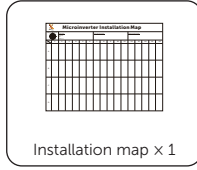
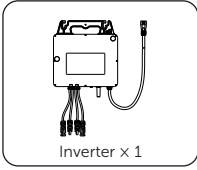

Sold separately:

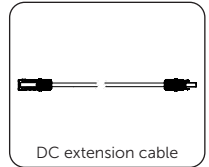
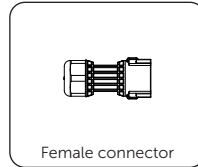
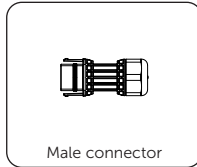
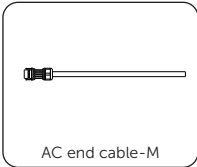
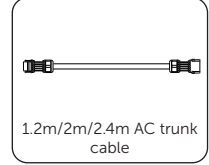
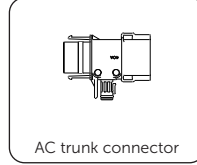
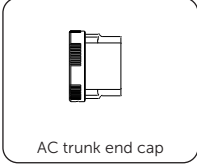

\* Refer to the actual delivery for the optional accessories. The quantity of materials in the packing list above is the recommended quantity for one microinverter. If you need to install multiple microinverters, the actual situation prevails.

## Installation Site

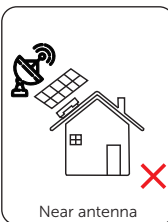
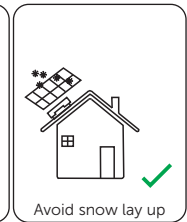
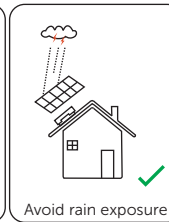
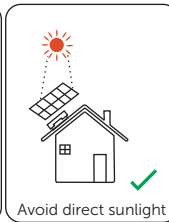
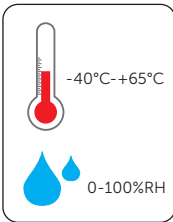

## NOTICE!

- For outdoor-installation, precautions against direct-sunlight, rain -exposure and snow-accumulation are-recommended.
- Exposure to direct sunlight raises the temperature inside the device. This temperature rise poses no safety risks, but-may impact the device performance.

## Installation Angle

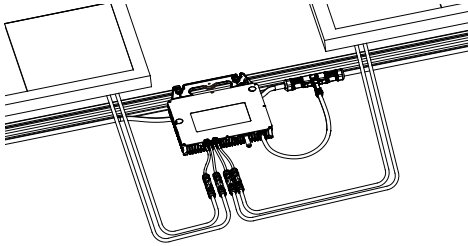

Parallel to the rail

## Installation Tools



Cable tie

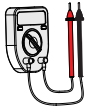

Multimeter

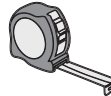

Measuring tape



Utility knife



Marker

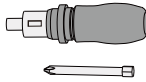

Torque screwdriver  
(Phillips head: M4)

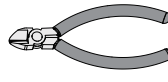

Diagonal pliers

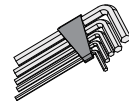

Allen key

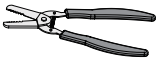

Wire stripper

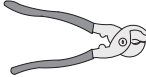

Wire cutter



Safety gloves



Safety boots



Safety goggles

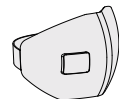

Anti-dust mask

## Additionally Required Materials

No.	Required Material	Requirements
1	AC circuit breaker	Current: 50A for 10 AWG/40 A for 12 AWG (If there are additional safety regulations, please refer to the local safety regulations)
2	Guide rail	According to actual needs
3	Sliding block	Matching with the guide rail
4	Screw	Matching with the guide rail
5	AC cable	4-6 mm <sup>2</sup> ; three-core soft wire cable

## AC Branch Circuit Capacity

X1-Micro 750/800/900/1000/1200 can be used with the provided AC Trunk Cable and AC Trunk Connectors. The maximum number of microinverters on each AC branch is listed as follows:

	X1-Micro 750		Maximum over current protection device
Maximum number per 12AWG branch	6@220V 6@230V 6@240V		40 A
Maximum number per 10AWG branch	8@220V 8@230V 8@240V		50 A
	X1-Micro 800	X1-Micro 900	Maximum over current protection device
Maximum number per 12AWG branch	5@220V 6@230V 6@240V	5@220V 5@230V 5@240V	40 A
Maximum number per 10AWG branch	7@220V 8@230V 8@240V	6@220V 7@230V 7@240V	50 A
	X1-Micro 1000	X1-Micro 1200	Maximum over current protection device
Maximum number per 12AWG branch	4@220V 5@230V 5@240V	3@220V 4@230V 4@240V	40 A

	X1-Micro 1000	X1-Micro 1200	Maximum over current protection device
Maximum number per 10AWG branch	6@220V 6@230V 6@240V	5@220V 5@230V 5@240V	50 A

### Appearance and Dimensions

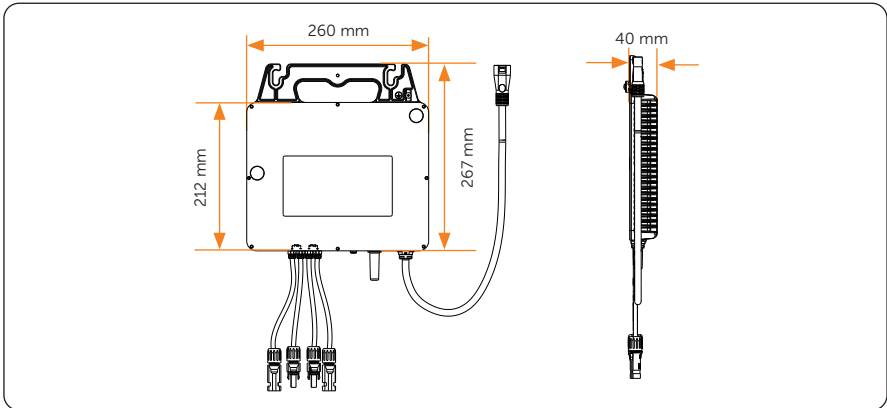

### Terminal Description

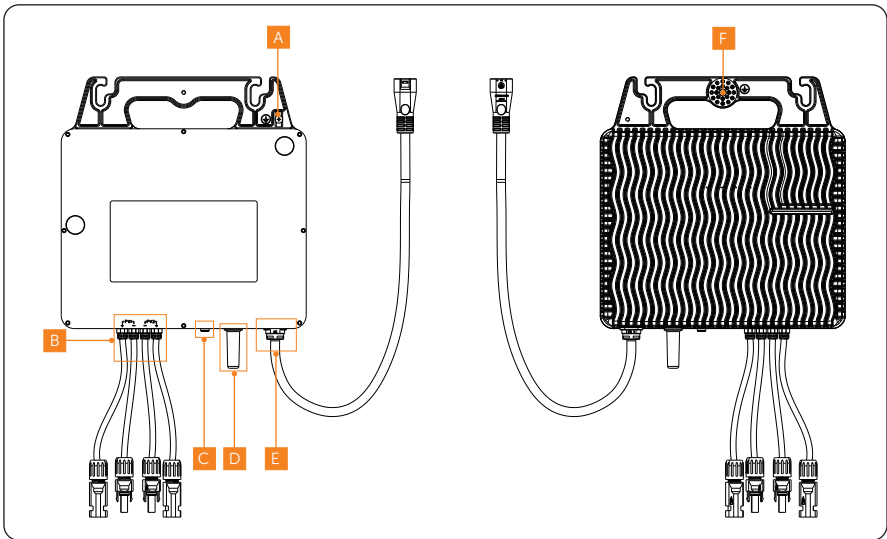

No.	Item	Description	Decisive voltage class
A	Spare ground cable clip	For standby earth connection.	
B	PV terminal	For PV connection.	DVC-C
C	Indicator	Show the status of the device.	
D	Antenna	To receive and transmit WiFi signal.	
E	AC terminal	For AC connection.	DVC-C
F	Earth lug	A connection component for electrical devices which need grounding (perferred grounding method).	

### Mechanical Installation

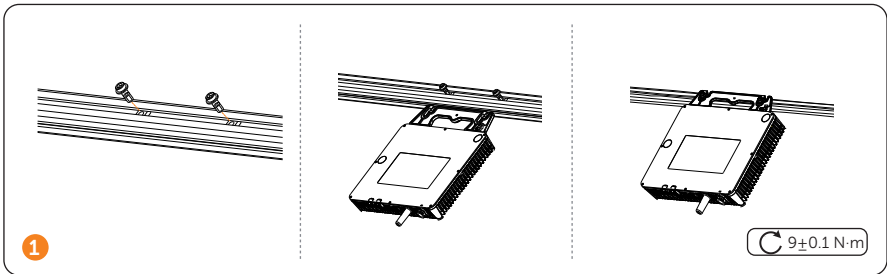

### NOTICE!

- Choose the screwdriver according to the corresponding screws of the rail.
- For multiple microinverters connection, please make sure the distance of each microinverter is less than 2.4 m.

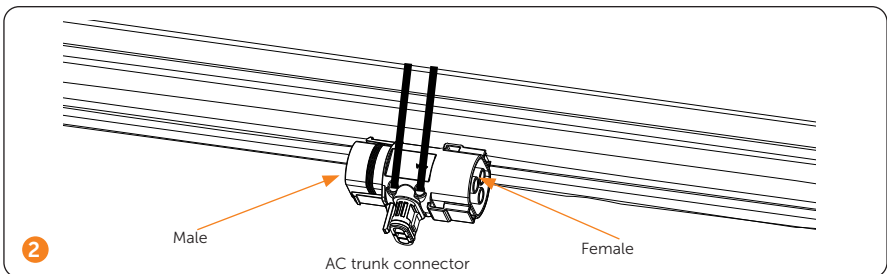

## NOTICE!

- In order to better fix the AC cable, it is recommended to use more cable ties to band the AC cable.
- Choose the cable tie according to the rail width and the length of self-purchased accessories.

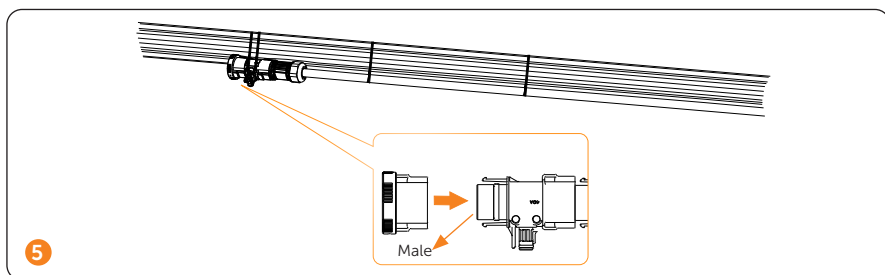
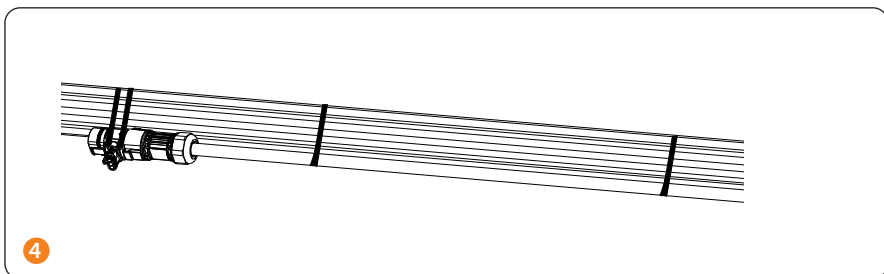
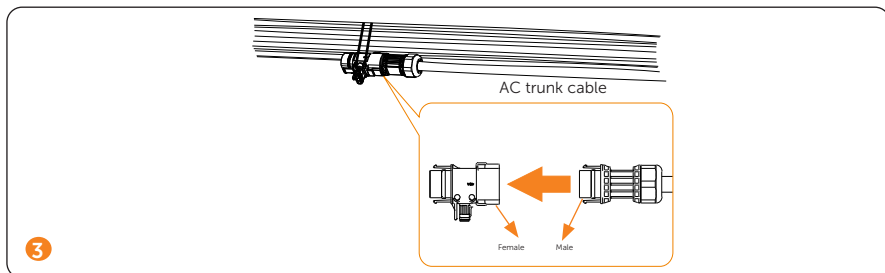

## NOTICE!

- The male head of the AC trunk connector connected to the first microinverter needs to be connected with the AC Trunk End Cap.

## NOTICE!

- If you need to remove the AC cable of microinverter from AC Trunk Connector, please use AC Trunk Port Disconnect Tool (see packing list).

## NOTICE!

- When connecting AC cables in the middle, please follow the diagram below.

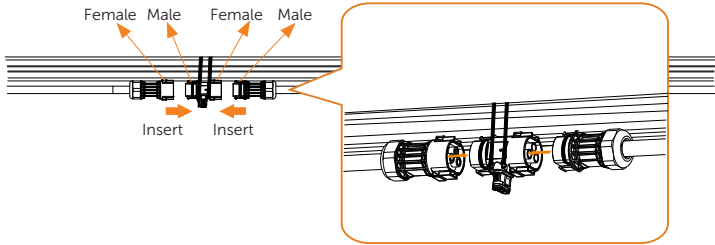

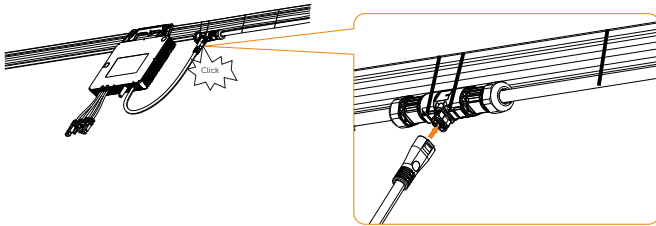

6

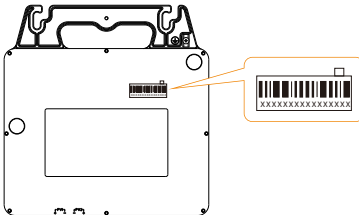

7



X SOLAR		Microinverter Installati								Customer information:	
Make sure to verify	Panel type:										
	Mounting:										
	Site:										
	Mounting:										
		1	2	3	4	5	6	7	8	9	10
A											
B											

## NOTICE!

- We provide two grounding methods for this series of microinverters. If the earth lug doesn't touch the rail or the rail is not on the ground, please try method 2.
- Select the appropriate grounding method according to local safety regulations.

Method 1 (major connection method):

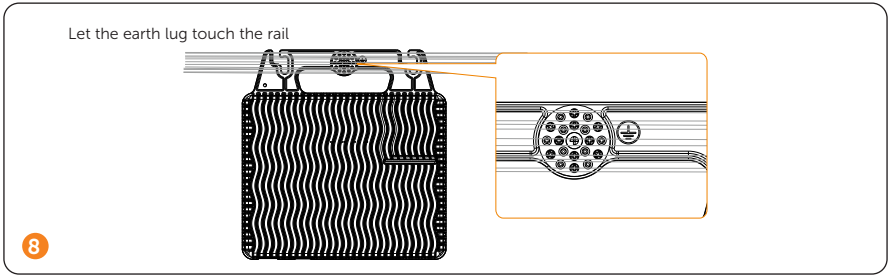

Method 2:

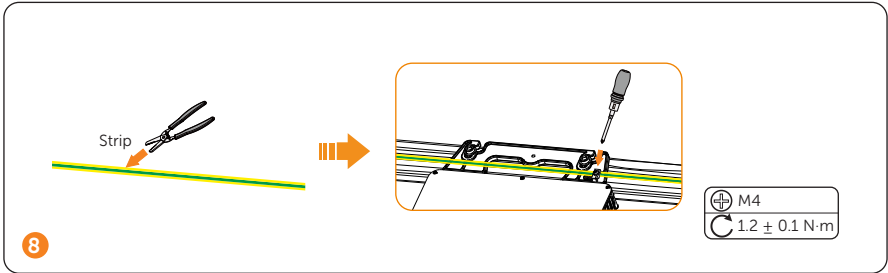

NOTICE!

- Step 10 and 11 should be finished by at least 2 or 3 trained and experienced workers.
- If the panels are too far from the microinverter, please use extended DC cable for connection.

WARNING!

- Please connect PV terminals in the correct way. Reverse connection may damage the microinverter!

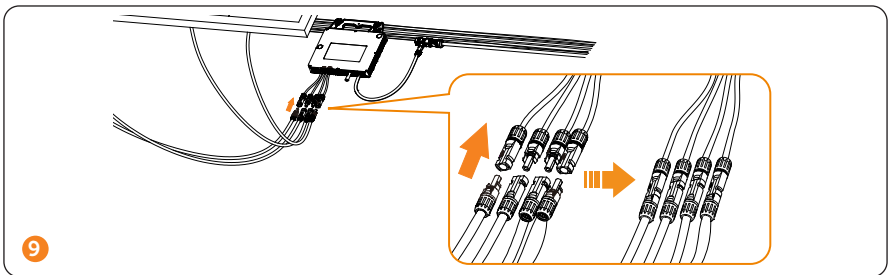

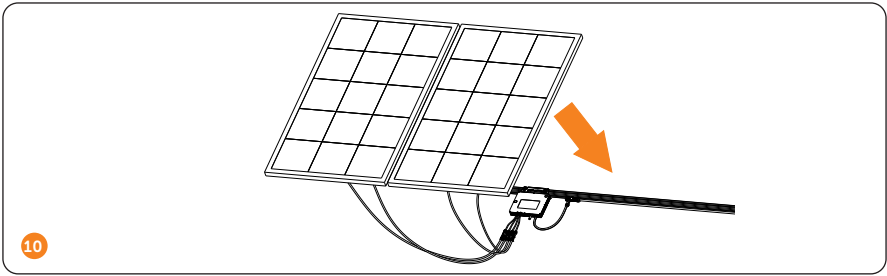

### NOTICE!

- After finish the installation, please fix the PV panels.

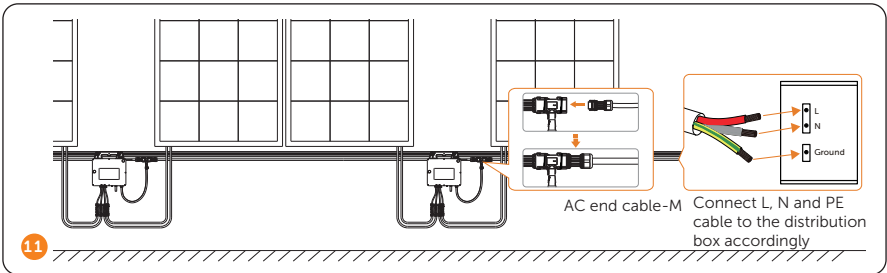

### NOTICE!

- The length of AC end cable shall depends on the actual installation scene.

### NOTICE!

- If you didn't buy AC end cable-M, please follow the procedures below to make the wire before connecting to the distribution box.
- Please use 4-6 mm<sup>2</sup> three core soft wire cable. Single core hard wire cable cannot be used in the following steps.

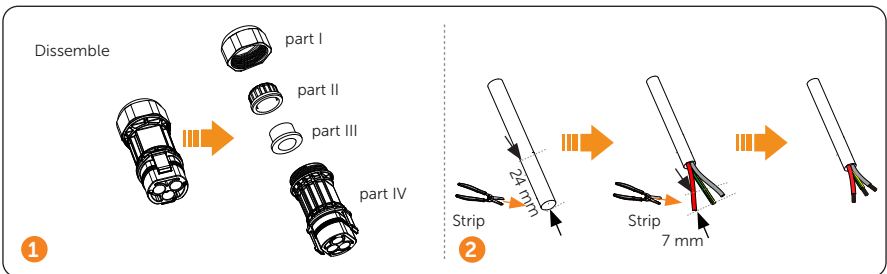

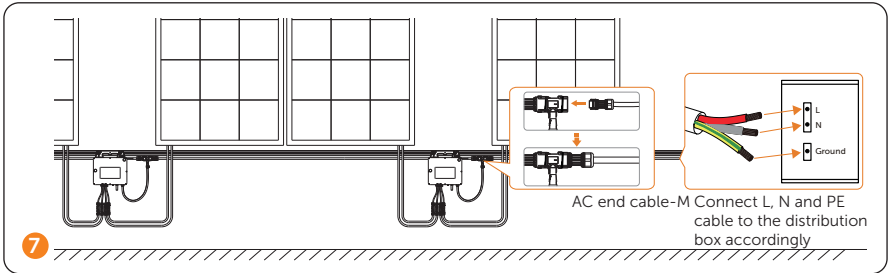
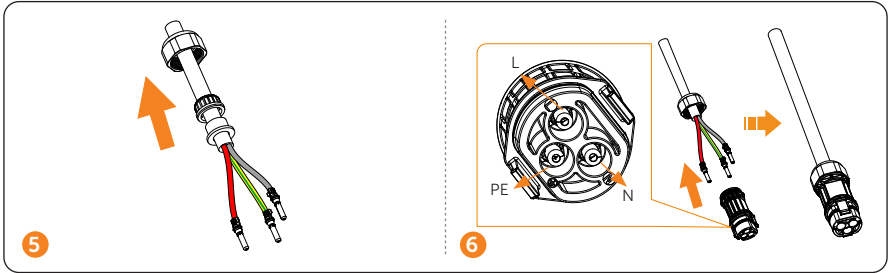
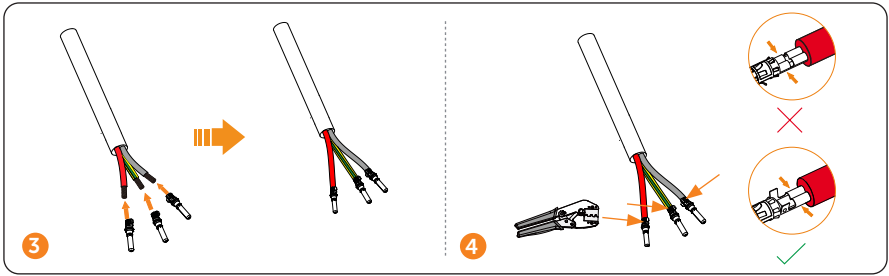

### NOTICE!

- Please check the connection stability between pin contacts with cable and connector using a pull force not exceeding 300N after crimping pin contacts and inserting the pin contacts with cable to the connector.

## Power on the System

Step 1: First turn on the AC breaker on the branch circuit and then the main AC breaker of the house.

Step 2: Wait for about 2 minutes until the system is initiated.

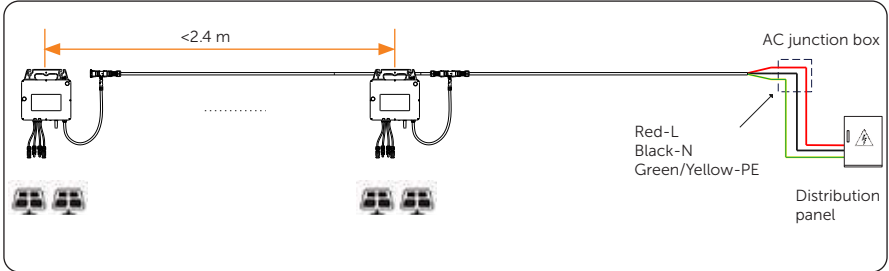

## LED Indicator Status

LED Indicator Status	Description
Yellow light flash	Microinverter startup. If the light flashes once in 1s, flashes in 10s or still flashes after 10s, microinverter startup fails.
Yellow light steady on	Microinverter standby/self-checking.
Green light flash (5s)	Normal operation; normal AC grid; communicating with router.
Green light flash (2s)	Normal operation; normal AC grid; no connection with router.
Red light flash (2s)	No AC grid or AC grid outside the regulatory range.
Red light steady on	Error: non-grid abnormal fault. Machine fault like grounding detection fault and PV side fault.

About 10s after connection with DC power, the light turns yellow;

The yellow light flashes for 10s continuously and then keeps steady on which stands for microinverter self-check;

Afterwards, if the system is not powered on, the red light will flash, indicating for no grid existence;

After microinverter connects with DC power for the first time, red light flashes indicates for errors during microinverter startup.

## Wi-Fi Configuration

**Step 1:** Scan the QR code below or search "SolaxCloud" to download the monitoring APP.



**Step 2:** Run the App, select the language, and touch [Sign up] at the bottom of Monitoring App.

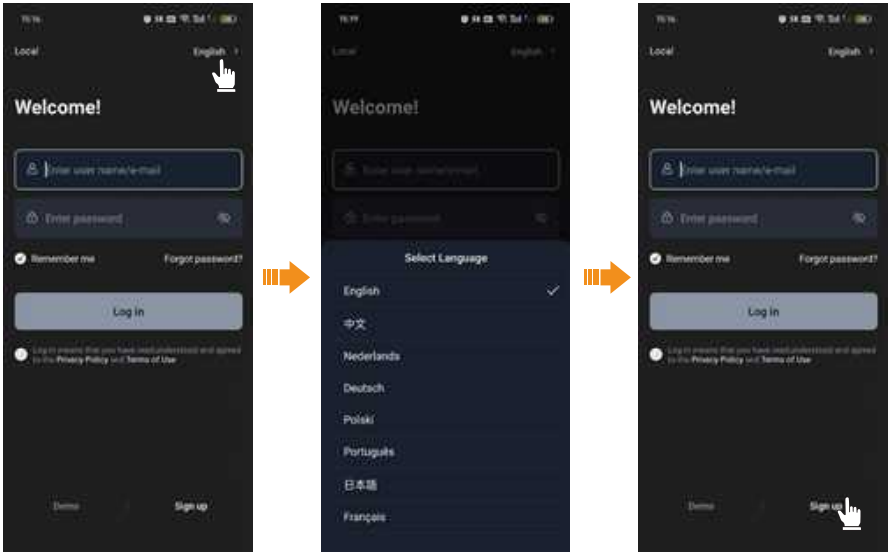

**Step 3:** Create the account. Log in the App after registration finished.

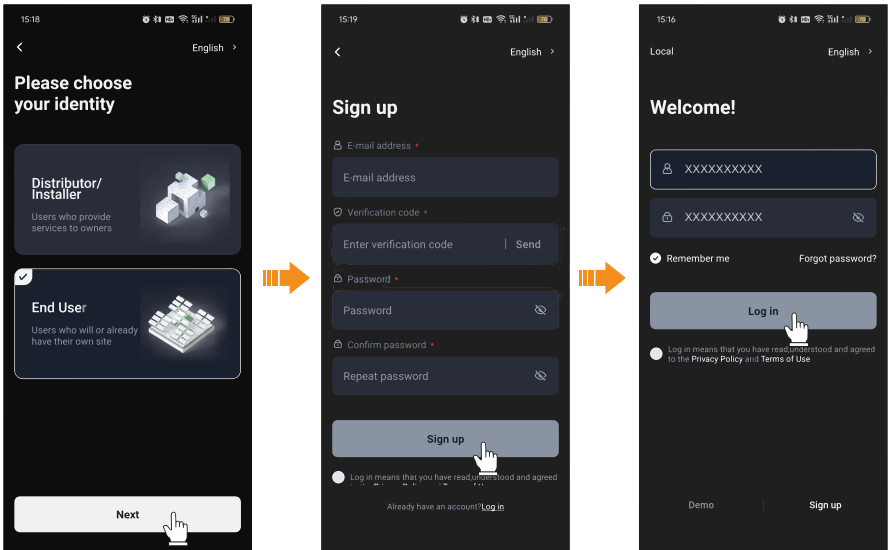

**Step 4:** Create a site by filling in the site information.

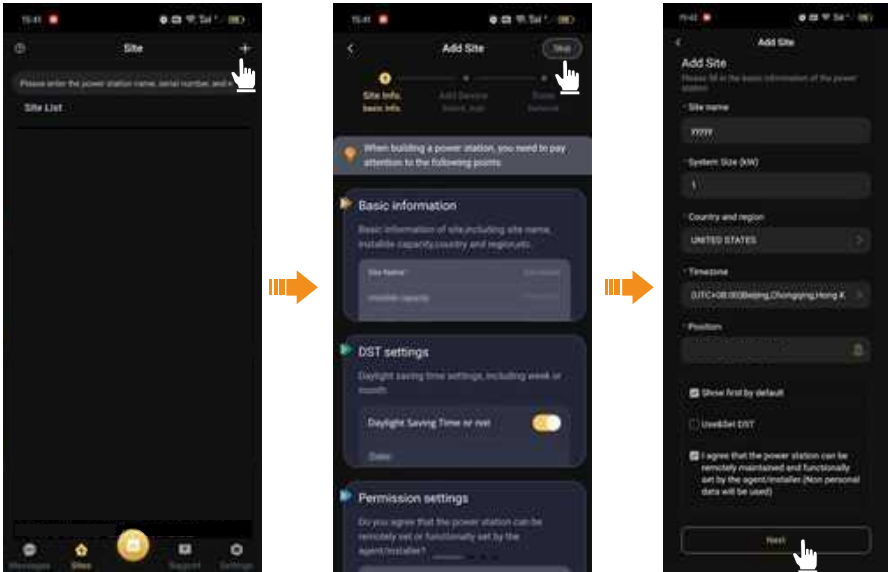

**Step 5:** Click [Microinverter], scan the QR code of microinverter to bind the device.

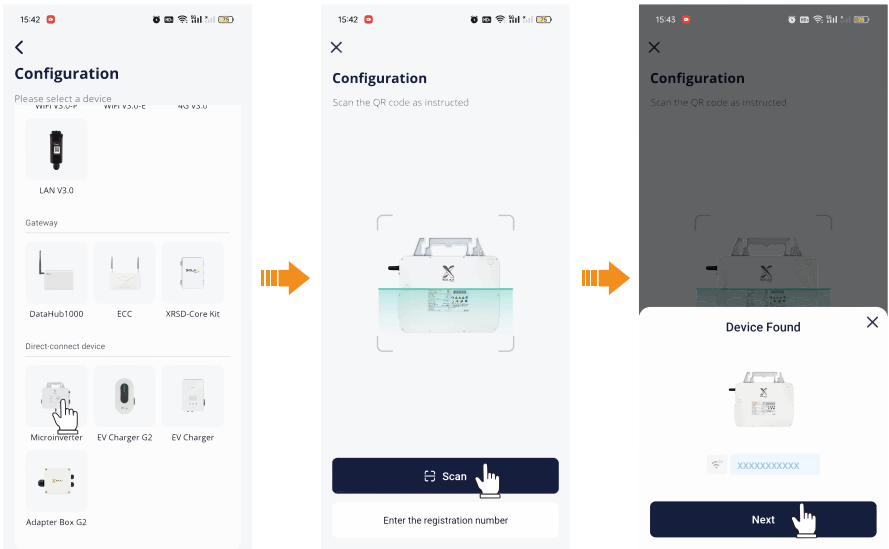

**NOTICE**

- If scanning the QR code step fails, then try to scan the one dimensional code. Scanning one dimensional code may lead to inaccurate scan results).

**Step 6:** Enter your WiFi account and password. Then, connect the device hotspot (name: Wifi\_XXXXXXXXXX), start to configure the device network.

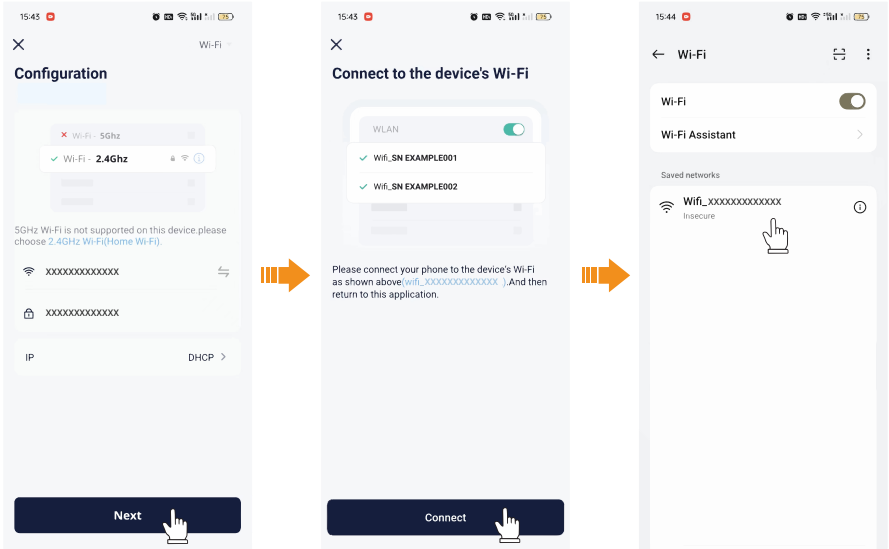

**NOTICE!**

- Before Network configuration, make sure the DC or AC side of the microinverter has been energized and the dongle module has been connected to "Upgrade/Dongle" port of the Microinverter .

**Step 7:** After configuration succeeds, please remember to change to your home WiFi for the following operations.

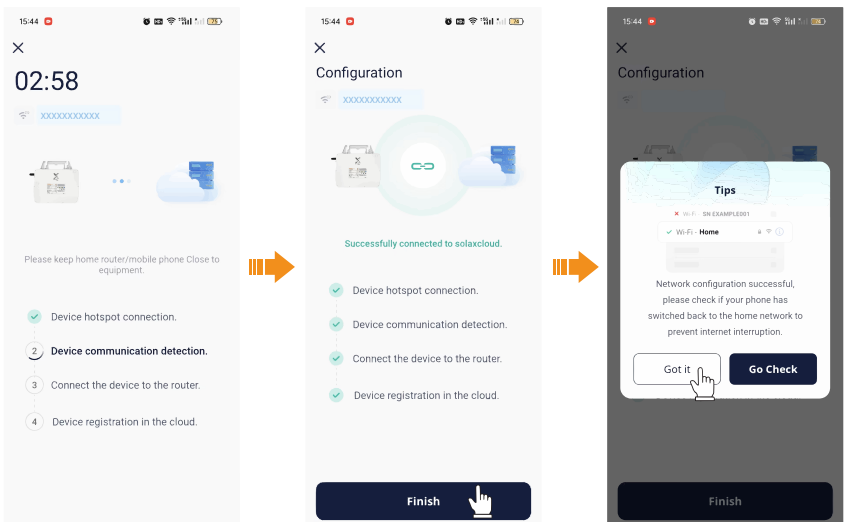

**Step 8:** Click [Layout] to customize your device layout and save the settings.

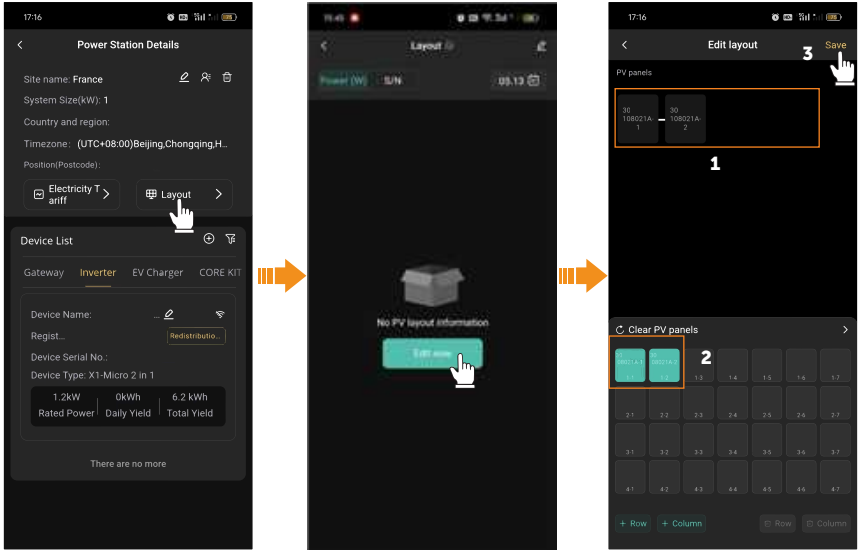

**Step 9:** Click the site to view your device detail information.

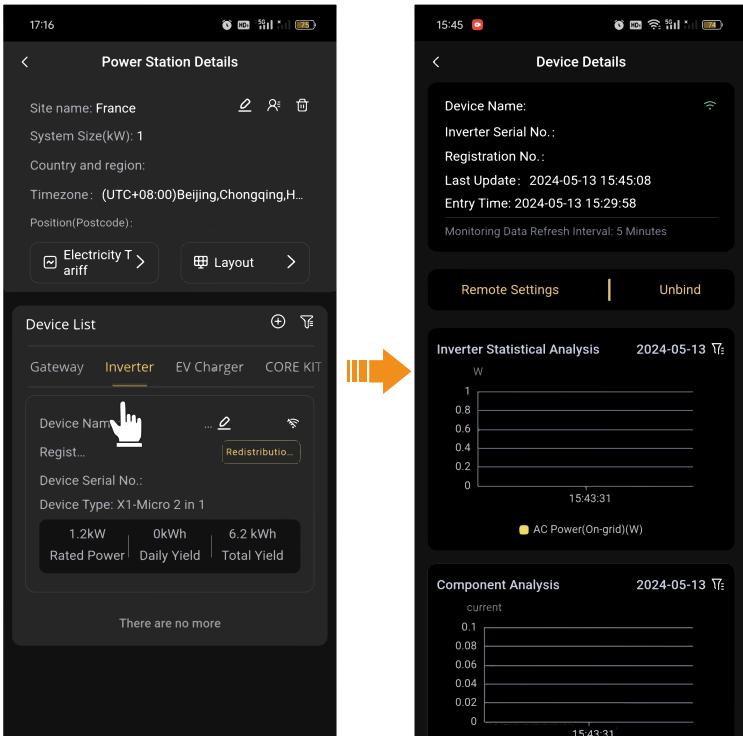

## Technical Data

### • DC Input

Model	X1-Micro 750	X1-Micro 800	X1-Micro 900	X1-Micro 1000	X1-Micro 1200
Max. recommended DC power [W]	240 to 470+	320-540+	360-600+	400-670+	400-670+
Max. PV voltage [d.c. V]	60				
MPPT voltage range [d.c. V]	22-60				
Nominal input voltage [d.c. V]	33				
Max. PV current [d.c. A]	2 × 15	2 × 15	2 × 16	2 × 20	2 × 20
Isc PV array short circuit current [d.c. A]	2 × 20	2 × 20	2 × 25	2 × 25	2 × 25
Max inverter backfeed current to the array [d.c.A]	0				
Start output voltage [d.c. V]	22				
No. of MPPT trackers	2				
Strings per MPPT tracker	1				

### • AC Output

Model	X1-Micro 750	X1-Micro 800	X1-Micro 900	X1-Micro 1000	X1-Micro 1200
Rated output apparent power [VA]	750	800	900	1000	1200
Maximum continuous output power [VA]	750	800	900	1000	1200
Nominal AC voltage [a.c. V] <sup>1</sup>	220 or 230 or 240 / 180-264				
Nominal AC frequency [Hz] <sup>1</sup>	50/45-55 or 60/55-65				
Rated output current [a.c. A]	3.41@220V 3.26@230V 3.13@240V	3.64@220V 3.48@230V 3.34@240V	4.10@220V 3.92@230V 3.75@240V	4.55@220V 4.35@230V 4.17@240V	5.46@220V 5.22@230V 5.00@240V
Power factor range	>0.99(-0.8~0.8 adjustable)				
Current inrush [a.c. A]	9@230V				
Max output fault current [a.c. A]	9@240V				
Max output overcurrent protection [a.c. A]	12				
Total harmonic distortion [%]	<3				

**Note:**

\*1 Nominal AC voltage/frequency range may vary according to local rules and regulations.

\*2 Refer to local rules and regulations for the specific number of microinverters per branch.

### • Efficiency, Safety and Protection

Model	X1-Micro 750	X1-Micro 800	X1-Micro 900	X1-Micro 1000	X1-Micro 1200
MPPT efficiency			99.9%		
Maximum efficiency			96.5%		
Security & Protection					
Safety	IEC62109, IEC63027				
EMC	IEC 61000, EN 62920, EN 301489, EN 55011				
Grid Connection Standard	IEC 61727, IEC 62116, EN 50549, ORDINANCE No. 140, ORDINANCE NO. 515, G98, VDE4105, C10/11				
Radio	2014/53/EU (RED), EN 300 328, EN IEC 62311				
Protection class	AC: I ; DC: II/III				
Ingress protection rating	IP67				
Pollution degree	PD 3				
Noise emission(typical) [dB]	<25				
Operating temperature range [°C]	-40 ~ 65 (> 45 Derating)				
Humidity [%]	0~100				
Storage temperature [°C]	-40~65				

### • Generic Data

Model	X1-Micro 750	X1-Micro 800	X1-Micro 900	X1-Micro 1000	X1-Micro 1200
Dimensions (W/H/D) [mm]			260 * 212 * 40		
Net weight [kg]			4.1		
Heat dissipation treatment	Natural convection				
Monitoring <sup>3</sup>	SolaXCloud				
Type of isolation	Galvanically Isolated HF Transformer				
Communication interface	Built-in Wi-Fi				

Note:

\* 3 SolaX monitoring platform.

# Contact Information



## UNITED KINGDOM

---



Unit C-D Riversdale House, Riversdale  
Road, Atherstone, CV9 1FA



+44 (0) 2476 586 998



service.uk@solaxpower.com



## TURKEY

---



Fevzi Çakmak mah. aslim cd. no 88 A  
Karatay / Konya / Türkiye



service.tr@solaxpower.com



## USA

---



3780 Kilroy Airport Way, Suite 200, Long  
Beach, CA, US 90806



+1 (408) 690 9464



info@solaxpower.com



## POLAND

---



WARSAW AL. JANA P. II 27. POST



+48 662 430 292



service.pl@solaxpower.com



## ITALY

---



+39 011 19800998



support@solaxpower.it



## PAKISTAN

---



service.pk@solaxpower.com



## AUSTRALIA

---



21 Nicholas Dr, Dandenong South VIC 3175



+61 1300 476 529



service@solaxpower.com.au



## GERMANY

---



Am Tullnaupark 8, 90402 Nürnberg,  
Germany



+49 (0) 6142 4091 664



service.eu@solaxpower.com



service.dach@solaxpower.com



## NETHERLANDS

---



Twekkeler-Es 15 7547 ST Enschede



+31 (0) 8527 37932



service.eu@solaxpower.com



service.bnl@solaxpower.com



## SPAIN

---



+34 9373 79607



tecnico@solaxpower.com



## BRAZIL

---



+55 (34) 9667 0319



info@solaxpower.com



## SOUTH AFRICA

---



service.za@solaxpower.com

# Warranty Registration Form



## For Customer (Compulsory)

Name \_\_\_\_\_ Country \_\_\_\_\_  
Phone Number \_\_\_\_\_ Email \_\_\_\_\_  
Address \_\_\_\_\_  
State \_\_\_\_\_ Zip Code \_\_\_\_\_  
Product Serial Number \_\_\_\_\_  
Date of Commissioning \_\_\_\_\_  
Installation Company Name \_\_\_\_\_  
Installer Name \_\_\_\_\_ Electrician License No. \_\_\_\_\_

## For Installer

### Module ( If Any )

Module Brand \_\_\_\_\_  
Module Size(W) \_\_\_\_\_  
Number of String \_\_\_\_\_ Number of Panel Per String \_\_\_\_\_

### Battery ( If Any )

Battery Type \_\_\_\_\_  
Brand \_\_\_\_\_  
Number of Battery Attached \_\_\_\_\_  
Date of Delivery \_\_\_\_\_ Signature \_\_\_\_\_

Please visit our warranty website: <https://www.solaxcloud.com/#/warranty> or use your mobile phone to scan the QR code to complete the online warranty registration.



For more detailed warranty terms, please visit SolaX official website: [www.solaxpower.com](http://www.solaxpower.com) to check it.

**Importer:**

**Authorised Representative (UK)**

**Name:** SOLAX POWER UK LIMITED

**Add:** Unit C-D Riversdale House, Riversdale Road, Atherstone, CV9 1FA

**Tel:** +44 (0) 2476 586 998

**E-mail:** service.uk@solaxpower.com

**Authorised Representative (AUS)**

**Name:** SolaX Power AUS Pty Ltd

**Add:** 21 Nicholas Dr, Dandenong South VIC 3175

**Tel:** +61 1300 476 529

**E-mail:** service@solaxpower.com.au

**Authorised Representative (EU)**

**Name:** SolaX Power NL Company BV

**Add:** Tweekeler Es 15,7547 ST, Enschede, Netherlands

**Tel:** +31 (0)85 2737 932

**E-mail:** service.eu@solaxpower.com



**SolaX Power Network Technology (Zhejiang) Co., Ltd.**

ADD.: No. 278, Shizhu Road, Chengnan Sub-district, Tonglu County,  
Hangzhou, Zhejiang, China  
E-mail: [info@solaxpower.com](mailto:info@solaxpower.com)

Copyright © SolaX Power Network Technology (Zhejiang) Co., Ltd. All rights reserved.



320102083407